

A Portable High-Performance
Microwave Spectrum Analyzer

Making Measurements
With The 492

A First Converter With Field
Replaceable Diodes

The Tektronix 492 Is A New-
Generation Spectrum
Analyzer

Packaging A Spectrum
Analyzer For Performance,
Maintainability And Survival

A Switching Power Supply For
The 492 Spectrum Analyzer

Volume 12
Number 1
1980

Tekscope

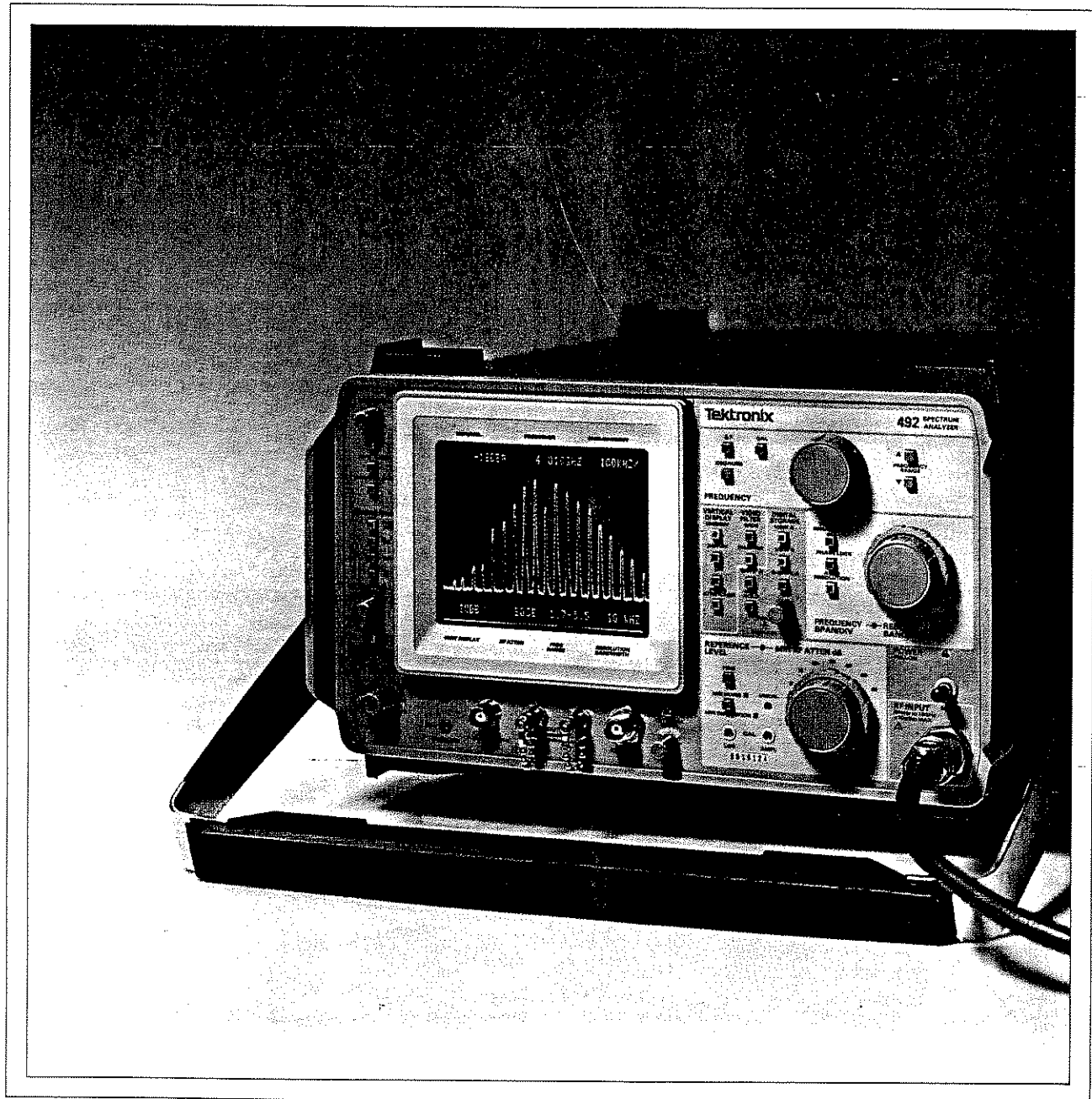

Tektronix
COMMITTED TO EXCELLENCE

CONTENTS

Tekscope

Customer information from
Tektronix, Inc.
Beaverton, Oregon 97077

Editor: Gordon Allison
Acting Editor: Art Andersen

A Portable High-Performance Microwave Spectrum Analyzer

The Tektronix 492 will make state-of-the-art measurements over the range of 50 kHz to 220 GHz, both in the laboratory and under severe environmental conditions.

The Tektronix 492 Is A New-Generation Spectrum Analyzer

A few years from now, someone will undoubtedly introduce a new spectrum analyzer that improves on the 492. But that is in the future. The 492 is here today.

Making Measurements with the 492

Some measurements showing the high stability and signal purity capabilities of the 492.

Packaging A Spectrum Analyzer for Performance, Maintainability And Survival

Designing and producing a portable package which would enable the 492 to meet MIL-T-28800B was a challenging experience. The key to success was the design of a crt capable of withstanding severe vibrations and shock.

A First Converter With Field Replaceable Diodes

Field replacement of mixer diodes exposed to excessive voltage is easy in the 492, but that is just one benefit.

A Switching Power Supply For The 492 Spectrum Analyzer

The weight of conventional supplies have made the high-performance portable spectrum analyzer a rarity until now.

Copyright © 1980, Tektronix, Inc. All rights reserved. Printed in U.S.A. Tektronix products are covered by U.S. and foreign patents, issued and pending. Information in this publication supersedes that in all previously published material. Specification and price change privileges reserved. TEKTRONIX, TEK, SCOPE-MOBILE, and  are registered trademarks of Tektronix, Inc. TELEQUIPMENT is a registered trademark of Tektronix U.K. Limited. For further information, contact: Tektronix, Inc., P.O. Box 500, Beaverton, OR 97077. Phone: 503-644-0161; TWX 910-467-8708; Cable: Tektronix. Subsidiaries and distributors worldwide.

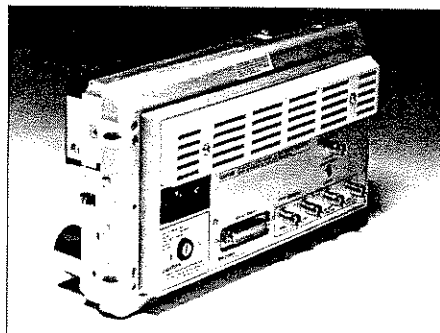
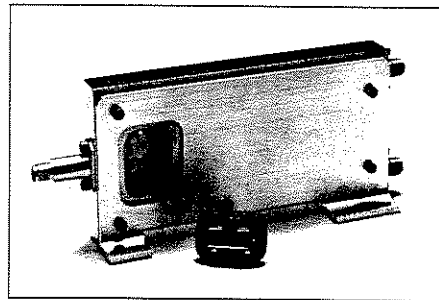
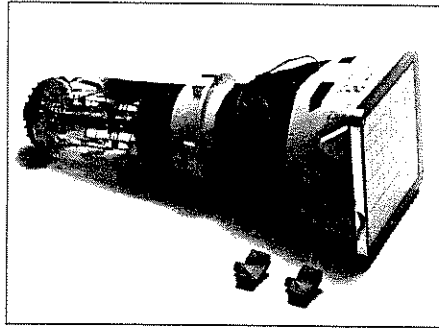
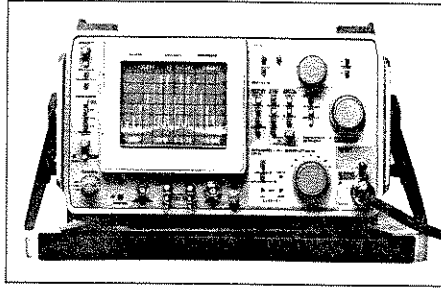

Tekscope is a bimonthly publication of Tektronix, Inc. In it you will find articles covering the entire scope of Tektronix' products. Technical articles discuss what's new in circuit and component design, measurement capability, and measurement technique. A new products section gives a brief description of products recently introduced and provides an opportunity to request further information.

Cover: The 492 Spectrum Analyzer, equally at home in the field as it is in the laboratory.

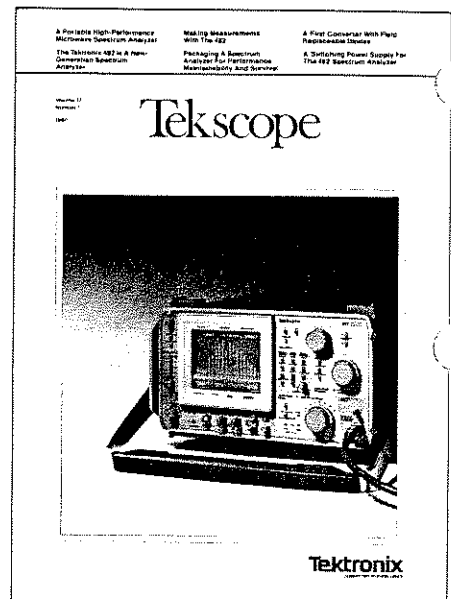

A Portable High-Performance Microwave Spectrum Analyzer.



Dave Morton received his Ph. D. from Iowa State University. Dave joined Tektronix in 1971 as a Project Engineer and has been associated with microwave circuit design and measurement. He currently manages the Tektronix Spectrum Analyzer Electrical Engineering Group and is a member of the IEEE and its Microwave Theory and Techniques Group. He and his wife and two daughters particularly enjoy the Oregon Coast in spite of the rain. Woodworking and photography are among his spare time interests.

It is often impractical to transport laboratory instruments to remote places and highly unlikely that, once transported, they will function properly under the environmental extremes encountered. Yet there is a growing need for laboratory spectrum-analyzer measurement capability at remote sites.

The Tektronix 492 meets this need for making state-of-the-art measurements over the range of 50 kHz to 220 GHz, both in the laboratory and under severe environmental conditions. This portable analyzer qualifies under the MIL-T-28800B, Type III, Class 3, Style C specification, a very rigid specification.

Much has been done in the 492 to make it easier to get the desired display on screen and make measurements precisely.

A simplified front panel

The uncluttered appearance of the front panel is achieved by removing the scales for the frequency, span, resolution bandwidth, and reference-level controls from the front panel. These parameters are displayed on the cathode-ray tube along with the signal. Thus, all the parameters required to properly characterize the display are available in one place.

The three main elements in a spectral display — frequency, frequency span, and amplitude reference — are controlled by three large knobs. Other controls are located where they are readily available.

In the 492 automatic coupling between primary controls is usually used to insure display calibration for virtually all selections. If the parameters manually selected are such that amplitude calibration is not maintained, a warning light indicates the *uncalibrated condition* and a "less than" symbol precedes the reference-level readout to indicate *uncalibrated value*.

The frequency-span control is concentric with the resolution-bandwidth selector and the switches that control span-related functions such as signal identification, phase-lock stabilization, and automatic resolution selection are situated nearby.

Concentric with the reference-level control is the minimum rf-attenuation selector. Vertical display factors, video filters, digital storage, and other signal processing function controls are also appropriately grouped for easier use.

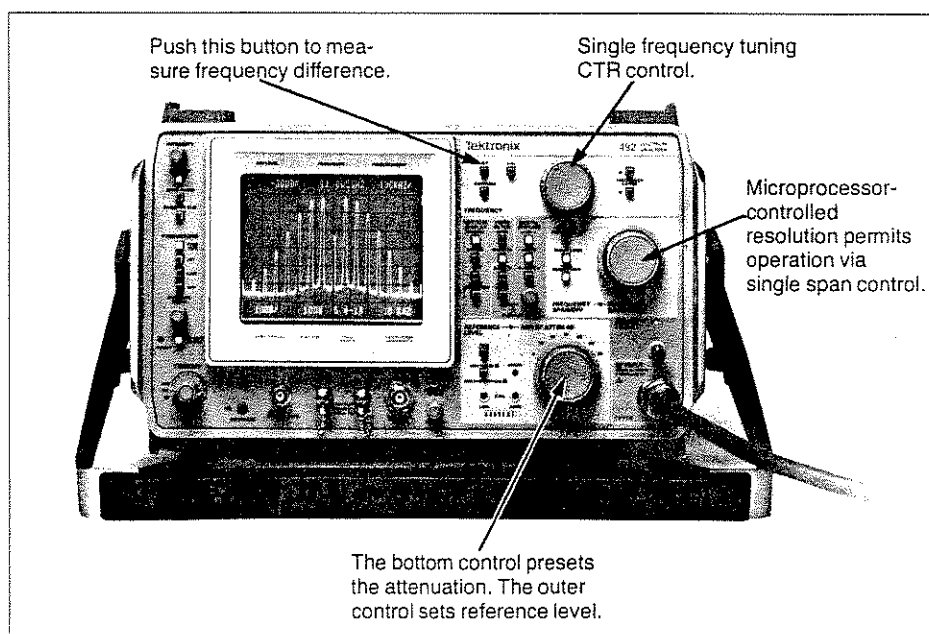

Figure 1. The three main elements, frequency, frequency span and amplitude reference, are controlled by three knobs.

Digital storage

The digital storage option provides flicker-free displays at the low sweep rates required for high-resolution measurements.

Two displays can be stored separately and displayed simultaneously for comparison, or the difference between the two signals can be displayed. In addition maximum signal levels can be captured and displayed.

The 492 with digital storage also provides an adjustable noise-averaging threshold to store and display signals that would otherwise be buried in the noise.

Single-knob wideband tuning

A most important spectrum analyzer function, tuning, is *digitally* controlled in the 492 by a Tektronix-designed optical switch.

Spectrum analyzers "tune" by varying the voltage applied to a voltage-controlled oscillator (vco). This is conventionally accomplished with a low-noise potentiometer and precise frequency selection is difficult.

With a resolution of about one part in two million, the tuning control of the 492 can set an oscillator with a 4 GHz range to within 2 kHz.

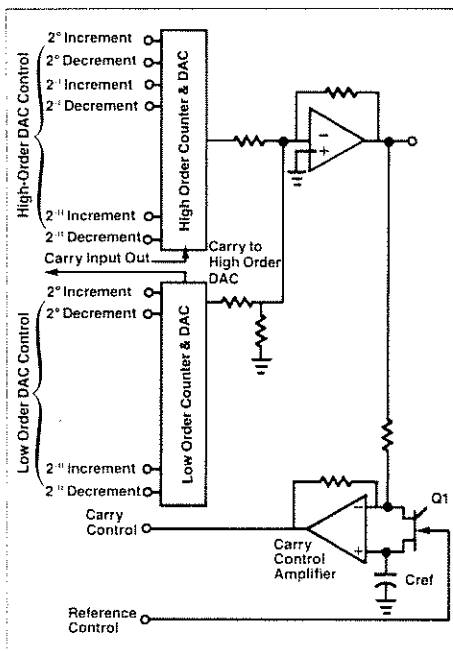

Figure 2. Timing is accomplished with a Tektronix-designed optical switch and two counter/digital-to-analog converter circuits.

Even finer tuning increments are effected in the 492, however, through the use of two separate digital-tuning systems. One controls the frequency of the YIG-tuned first local oscillator through its main, or coarse, tuning coil. The second controls the second local oscillator. The tuning rate, referred to the frequency span displayed, is essentially constant for all frequencies and is set with a single control knob.

Coupled-control operation

In the 492 the resolution bandwidth is normally operated in the automatic mode. In AUTO RESOLUTION the bandwidth is 1 MHz for the wider spans. It is reduced automatically in decade steps as the span is decreased to maintain a convenient span-to-resolution bandwidth ratio. The TIME/DIV control is usually set to automatically select the fastest sweep speed compatible with resolution. This assures proper amplitude calibration.

Thus when the span-control setting is changed, resolution bandwidth and time per division are set automatically to provide a calibrated display. Either control function can be manually operated.

Zero span is a mode in which no sweep is applied to the internal local oscillators and the sweep displayed is a *time base* set by the TIME/DIV control. In this mode the 492 may be used as a modulation waveform display device with the time-per-division value displayed on the crt.

Single knob reference level control

Reference level setting in the 492 is greatly simplified by using a single control and by microprocessor control of intermediate-frequency gain to *automatically compensate* for the rf attenuation selected. When the 492 is turned on, rf attenuation is automatically set to 60 dB to protect the input against inadvertent applications of a large signal.

Attenuator changes are prohibited in the differential amplitude measurement mode in order that highly accurate intermediate-frequency substitution-type measurements can be made. An example of this substitution technique is described in the article "The 492 Is A New Generation Spectrum Analyzer" in this issue.

The internal control system

The simplified front panel and the ease with which measurements can be made with the 492 are benefits realized largely by firmware microprocessor control.

Interconnection of the many circuit functions to the control microprocessor is by means of static address and data buses. A static-bus system prevents control-signal interference with sensitive rf and analog circuitry.

Each of the controlled modules latches its own control status instructions until change is necessary. To maximize communications efficiency, controlled modules are designed to operate without the burden of scanning the front-panel settings continuously. When a front-panel control is changed, the new setting is encoded and a processor interrupt is generated. The processor then initiates the necessary actions.

The system firmware that administers the control is modular. This simplifies maintenance and repair.

After the power is turned on the processor reads headers in the control-system roms. As each required module is found, its corresponding starting address is read from the header and stored in a table in system ram. The table can be filled in any order, thus the modules may exist in the rom in any convenient order. The rom is searched from low-to-high-order address. Since only the first header reference to a given module is recorded in the ram table, repairs are made by simply placing a desired routine at a lower address location.

The run-time linker just described is quite circumspect. A run-time linker allows repair of routines in production, as well as facilitating firmware configuring for the version of the 492 ordered (a number of options are offered.) If, for example, the digital-storage hardware module is not installed, the run-time linker will not attempt to load the digital-storage module starting address, and the 492 will operate as a non-digital-storage instrument. Such a design enhances the ability to keep the 492 in service should a failure occur. Further, once one set of roms contain the firmware modules for all instrument configurations, firmware can be replaced easily and unambiguously.

Signal handling and processing

A high-performance spectrum analyzer must have a superb signal-handling system to make state-of-the-art measurements. In the 492 state-of-the-art rf subsystems include a 60 dB step attenuator, a three-stage tuned yig preselector, and a 50 kHz to 21 GHz input mixer. (See "First Converter" With Field Replaceable Diodes in this issue.)

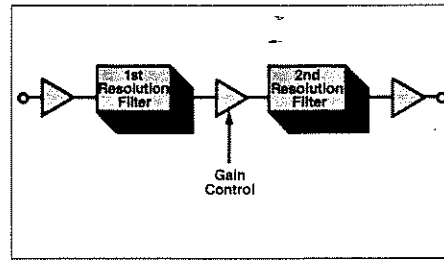

Figure 3. The distributed filter configuration eliminates the need for a wide-dynamic-range, low-noise, controlled-gain amplifier.

The first local oscillator is tunable over a greater than 4 GHz range, covering the 50 kHz to 21 GHz basic frequency range of the 492 in only five bands, while avoiding spurious-signal displays (undesired mixer conversion products.)

Depending on the frequency band selected one of two first intermediate frequencies (829 MHz or 2.072 GHz) is used. The 2.072 GHz first i-f is used with external mixers to cover the 18 to 220 GHz bands to minimize the display of image frequencies. With two first intermediate frequencies two second local oscillators are required to convert to the 110 MHz second i-f. A 100 MHz crystal-based oscillator provides conversion to the 10 MHz third i-f.

The variable-resolution filters in the 492 have a shape factor of 7.5 to 1. This is achieved by using a distributed filter configuration as shown in figure 4. This eliminates the need for a wide-dynamic-range, low-noise, controlled-gain amplifier at the output of the variable resolution section. Bandwidths of 1 MHz to 100 Hz are selectable in decade steps.

The logarithmic amplifier is similar to that used in other Tektronix spectrum analyzers. The pulse stretcher function and fine reference-level adjustments also occur here.

Finally, after detection, the signal is routed through the video filters (if selected) and to the digital-storage circuitry. Instrument-parameter information for the crt readout is multiplexed with the video information in the deflection amplifier circuitry.

Programmability

The programmable version of the 492 is designated 492P. This version of the 492 is fully programmable by means of the IEEE 488-1975 (GPIB) standard. The 492P retains all of the front-panel controls of the nonprogrammable instrument. Since these controls are digitally interfaced, an instrument "status profile" is available upon request by a controller such as the Tektronix 4051 Graphic Computer System.

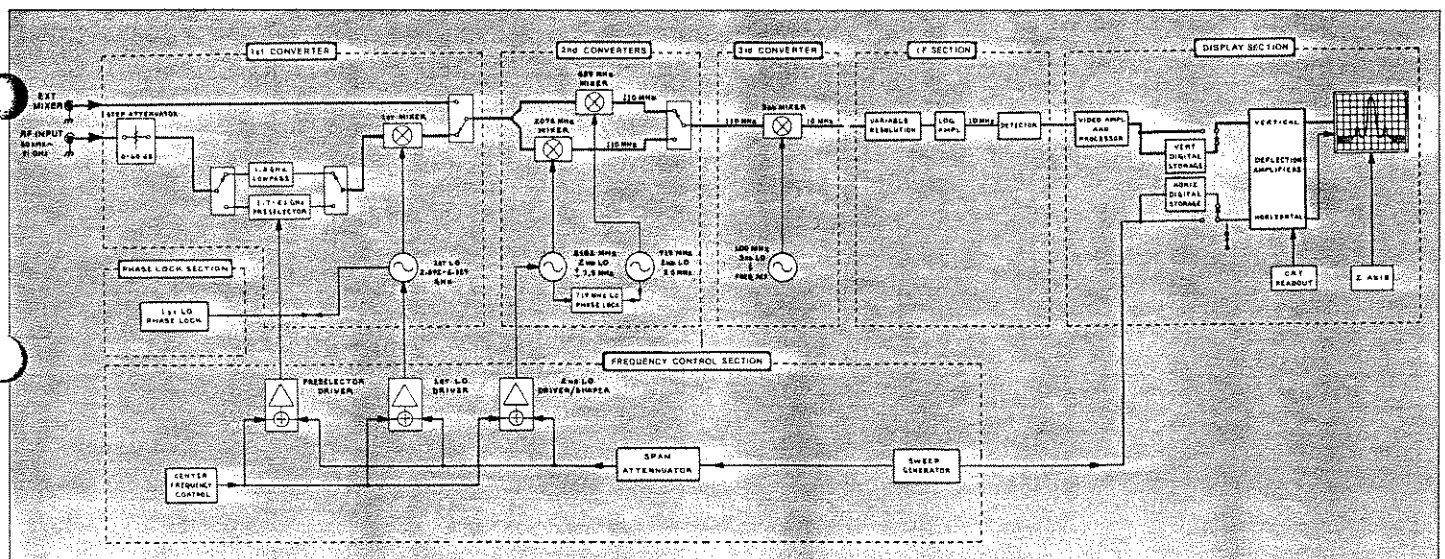

Figure 4. Simplified block diagram of the 492 Spectrum Analyzer.

The Tektronix 492 is a New-Generation Spectrum Analyzer



Morris Engelson, Marketing Manager of Frequency Domain Instruments, has written three books and between 30 to 40 papers ("depends on how you count" says Morris.) He helped Tektronix enter the spectrum analyzer field fifteen years ago. He holds a BEE and a MEE from C.C.N.Y. An ex-New Yorker, Morris likes the Northwest and is active in school board activities. His concern for his family and others is evident from his efforts in keeping alive the lessons of the Holocaust by talking to people in schools and other organizations.

Since the first spectrum analyzers were introduced more than forty years ago, many improvements have been made in technical performance, ease of use, physical and environmental capability, and price/performance relationships. The recently introduced Tektronix 492 Spectrum Analyzer provides advances in all these areas, and its wide range of options permits the user to select the optimum price/performance combination for his application.

Frequency range

The top frequency setting on commercially available spectrum analyzers has been 60 GHz. The options available on the 492 extend this upper frequency limit to 220 GHz, while maintaining a lowest characterized frequency of 50 kHz.

Two technological factors contributed to this high-frequency-end breakthrough of the 492. The first was the development by Tektronix several years ago of the first broadband, fully-amplitude-calibrated waveguide mixers to 60 GHz for use with the 7L18 spectrum analyzer. Operating on the fifteenth harmonic of the 7L18's 4-GHz local oscillator, these mixers exhibit only 30 dB of conversion loss. The 492 is designed to use the same mixers.

The second factor is the use in the 492 of a 2-to-6.3 GHz local oscillator rather than the traditional octave-range 2-to-4-GHz local oscillator. The new local oscillator makes possible higher operating frequencies at lower harmonic conversion numbers. As a result, the 492 has full frequency and amplitude calibration to 60 GHz using Tektronix broadband waveguide mixers. In addition, full frequency span and input-frequency calibration are provided to take advantage of commercially-available mixers to 220 GHz. Thus, millimeter-wave spectrum analysis is extended by 160 GHz!

Resolution

The resolution bandwidth of the 492 is from 100 Hz to 1 MHz. Combined with less than 50-Hz incidental fm and the wide operating range of the first local oscillator, the 100-Hz resolution bandwidth setting is perfectly usable over the full coaxial input-frequency range of 21 GHz. Indeed, respectable measurements at 100-Hz resolution setting are possible even at 60 GHz. In addition, sideband noise is sufficiently low to permit easy observation of 70-dB-down signals only 3 kHz removed from a carrier in fundamental mixing mode.

Stability

Drift, incidental fm, and phase noise sidebands are some of the considerations involved in stability. An area that is not usually discussed is how easily the instrument can be stabilized and how well it will stay stabilized.

Although automatic phaselock is no longer special, the 492 has the advantage of staying phaselocked no matter what external temperature change or other adverse frequency-destabilizing conditions are experienced. This performance is a result of routine monitoring of various internal spectrum-analyzer functions by a microprocessor.

Whenever frequency drift threatens to disturb phase lock, the microprocessor readjusts the local-oscillator tuning voltage to maintain balance. The advantage of this system is that continuous frequency restabilization is not necessary, and ease of measurement is improved.

Dynamic range

A preselector-equipped 492 provides a full 80-dB on-screen display with 100-dBc harmonic measurements.

Sensitivity

Sensitivity for the 492 is -123 dBm at 100-Hz resolution setting for fundamental conversion in a non-preselected instrument. Because of the wide frequency range of the first local oscillator, fundamental conversion extends to over 7 GHz.

Amplitude accuracy

Besides a typical absolute amplitude measurement accuracy of 3.3 dB, the 492 introduces amplitude comparison in 0.25-dB steps by means of its differential amplitude (ΔA) function. This variation of the i-f substitution technique provides 200 quarter-dB steps for precision amplitude comparison over a 50-dB range. The result is improved ease and accuracy whenever relative amplitudes have to be determined, such as in AM, FM, or pulse signal measurements.

Programmability

All front-panel measurement settings are fully programmable via the IEEE-488 General Purpose Interface Bus in the programmable 492P. Control settings and signal display information can be manipulated by a controller such as a Tektronix 4050 Series Graphic Computing System intelligent terminal.

Technical performance

In the area of technical performance, the 492 introduces advances in three of the seven most-quoted performance specifications (highest input frequency, microprocessor phaselock control, and quarter-dB amplitude comparison) without sacrificing the high standards of performance that users have come to expect from modern spectrum analyzers. The result is an instrument that covers the full radio-frequency spectrum (including much of the millimeter-wave area), that stays phaselocked, and that provides a new standard in relative amplitude measurements. Some of these capabilities are illustrated in the accompanying photographs.

Figure 1 shows a 104-GHz signal displayed on the 492. The internal noise level is 40 dB below full screen, providing 40-dB measurement range at 1-MHz resolution setting.

Figure 2(a) shows two signals of slightly differing amplitude level. The vertical display has been set to 2 dB/div, and the reference level in the upper left corner is set for 0-dB reference in preparation for amplitude-difference measurements. Figure 2(b) shows the same signals after the smaller signal has been set to full screen. The change in level setting shows as 3.25 dB.

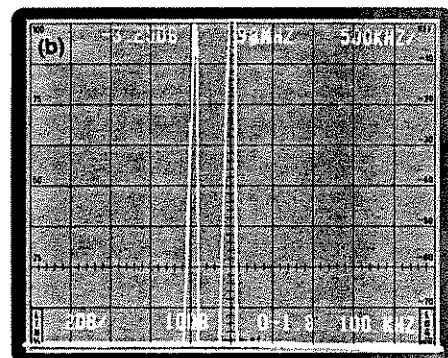
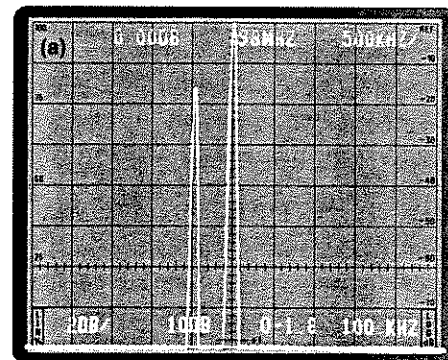

Figure 2. Amplitude comparison measurements can be made within 0.25 dB as illustrated in these two photos.

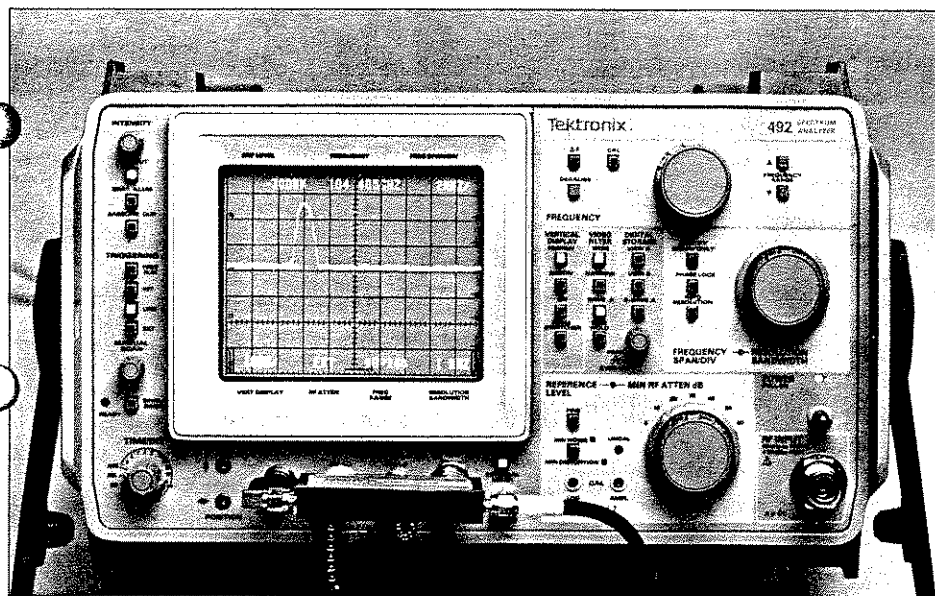

Figure 1. High frequency performance of the 492 is demonstrated in this photo of a 104 GHz signal displayed with 1 MHz resolution.

Making Measurements with the 492

By Morris Engelson,

Spectrum Analyzers are used for a large variety of measurements in applications ranging from EMC to doppler radar, and from FM broadcasting to oscillator purity determination. Whatever the application the primary emphasis is on checking the amplitude and determining frequency spectrum distribution of a signal. The following applications illustrate some conventional and some not so conventional capabilities of the TEKTRONIX 492 Spectrum Analyzer.

Using digital storage in FM measurements

A common spectrum analyzer application in FM is establishing deviation by the bessell-null technique. The usual procedure is to change the deviation setting which produced the display (shown in figure 1) until a carrier null is obtained as illustrated in figure 2. In figure 2 we observe the first carrier null at a modulation index of 2.4. Since the modulation frequency is 10 kHz peak deviation is calculated to be 24 kHz ($2.4 \times 10 = 24$ kHz).

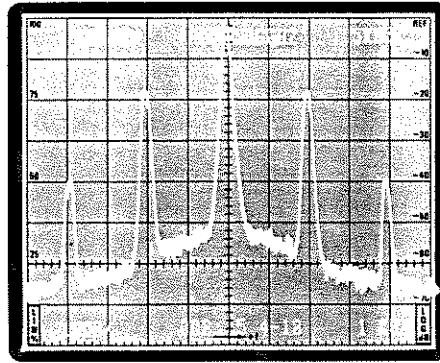

Figure 1

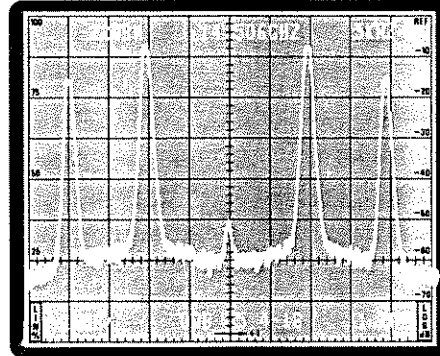

Figure 2

After establishing deviation it is sometimes difficult to get back to the original setting. Use of the *SAVE* feature of digital storage makes reproduction of original settings easier. This is illustrated in figure 3 where the original spectrum is saved in one memory while the bessell-null condition is displayed by the second memory. After the measurement is completed the original spectrum display, held in the first memory, is available as a guide for re-establishing the original equipment set up. These measurements were performed at 14.5 GHz. Yet the display is clean and your ability to resolve the FM sidebands is unimpaired.

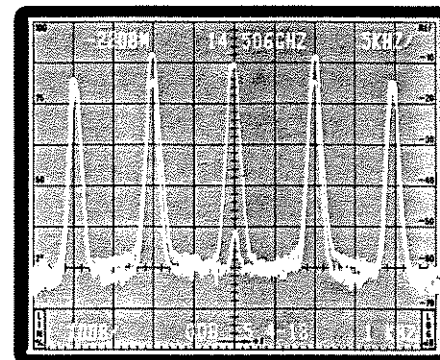

Figure 3

Signal purity and stability measurements

The high stability and signal purity capabilities of the 492 have already been shown in the previous photos at 14.5 GHz.

The 492 is excellent for measuring close-in sideband noise because of its high stability and purity of signal reproduction. In figure 4 the noise level is almost 60 dB down at a point only 500 Hz away from the 6 GHz carrier, improving to 70 dBc at 2 kHz offset from the carrier. These measurements were made using a resolution setting of 100 Hz. The exceptional capability for clean displays designed into the 492 is illustrated in figure 5 which shows the resolution of 500 Hz sidebands at an input frequency of 21 GHz.

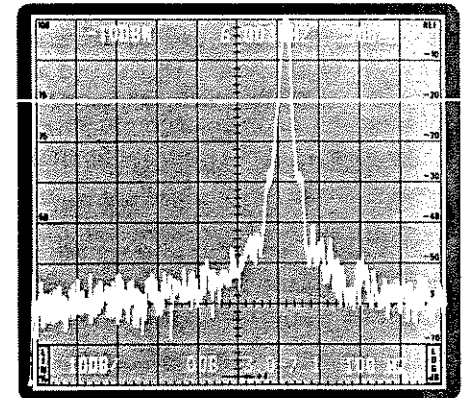

Figure 4

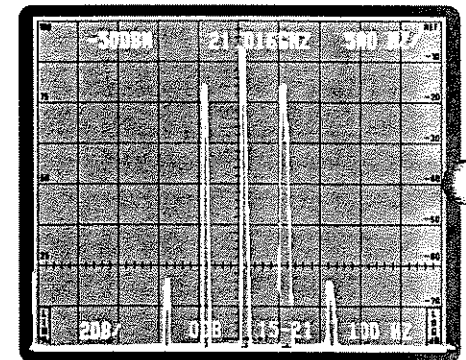

Figure 5

Using the delta modes

The 492 features differential amplitude and differential frequency modes that provide easier means for you to make these measurements. The delta A mode increments in 0.25 dB steps, greatly improving measurement accuracy over other techniques.

After the carrier peak is set to the full-screen reference the differential amplitude mode is activated setting the reference level to 0.00 dB (upper left corner of figure 6). The first sideband on the left is then positioned to the top of the display with the reference level control and is determined to be at 3.00 dB below carrier (figure 7). The right sideband is at -3.50 dBc (figure 8) and the next set of sidebands are 16.25 dB down from carrier (figure 9). The 492 provides over 50 dB of measurement range in the delta amplitude mode in increments of 0.25 dB.

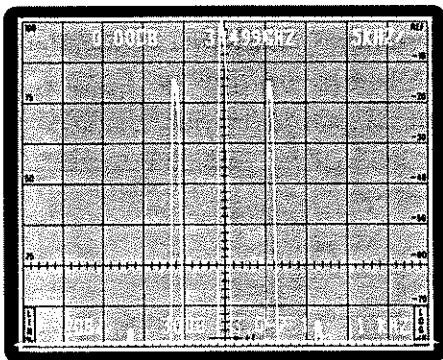

Figure 6

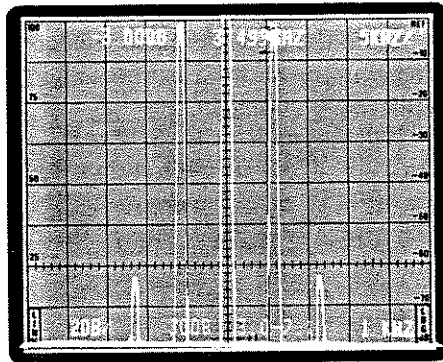

Figure 7

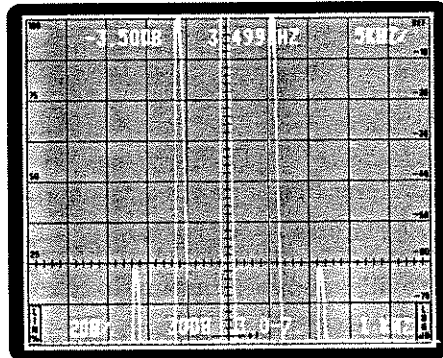

Figure 8

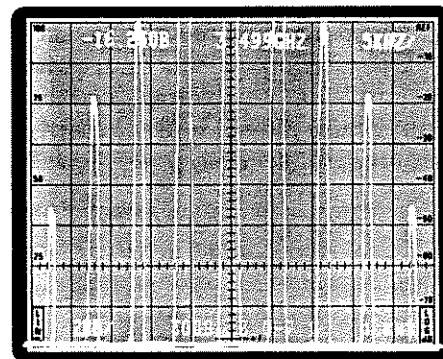

Figure 9

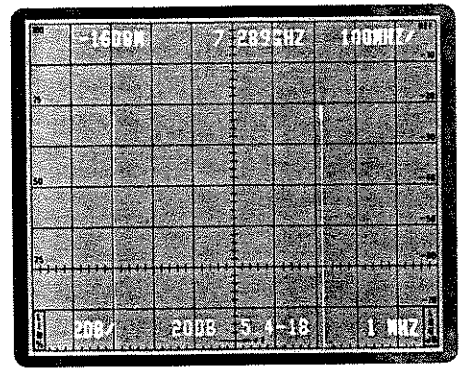

Figure 10

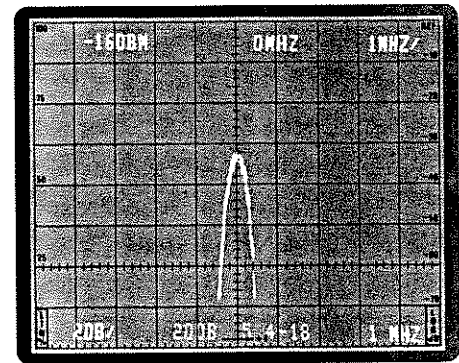

Figure 11

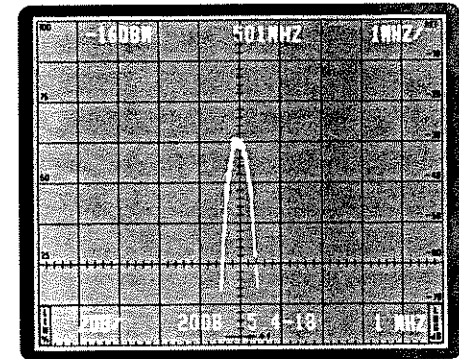

Figure 12

The frequency difference (ΔF) mode enhances the measurement accuracy when determining frequency differences between widely spaced signals. In figure 10 two signal components appear to be 500 MHz apart. But, is the separation precisely 500 MHz or 510 MHz, or 493 MHz, or what? By reducing the span to 1 MHz/div. and activating the frequency difference mode, the frequency readout is set to 0 MHz reference (upper center of figure 11). Tuning the next signal to center screen we note that the frequency spacing is 501 MHz (shown in figure 12).

Packaging a Portable Spectrum Analyzer for Performance, Maintainability, and Survival.



Carlos Beeck was born in Lima, Peru. He came to the United States as an Air Force Cadet for engineering training. Carlos has a BSME from the California Institute of Technology and received an aeronautical engineering degree from Cal-Aero. At Tektronix since 1968, Carlos has participated in component and advanced mechanical engineering projects including work on the 7L5, TR 501, TR 502, 7L13, 7L18, and 492. He holds patents for the opto-switch and the rf hybrid package. Outside interests include wood working, inventing and painting.

The design goals for the 492 spectrum analyzer package included meeting the standards of the rigid military specification MIL-T-28800B, Type III, Class 3, Style C. In addition, the 492 had to be suitable for laboratory environments. The instrument also had to be readily maintained.

A rugged frame

Aluminum castings, combining strength with lightness, are used for the basic frame structure of the 492. There are a front and rear casting, and two identical side-rail castings. The rf deck spans the bottom portion of the frame tying the structure together.

A longitudinal member from the front casting to a transverse member adds further strength and provides support for plug-in circuit modules.

These modules plug into a mother board and are secured with screws. Any module can be readily removed for repair or be serviced on an extender board. The front-panel assembly and low-voltage power supply also plug-in and are easily removed for servicing.

Crt considerations

The best shock survival for a crt of the size available for the 492 was about 40 g's. Testing to MIL-T-28800B indicated that the crt should withstand accelerations of at least 100 g's.

Using computer analysis it was determined that the vibration dampers, which maintain the position of the electron gun in the crt neck, should be enlarged to produce a tube capable of withstanding in excess of 120 g's.

This rugged crt was then uniquely cantilevered from the front casting in a system of glass-filled nylon mounting wedges. These wedges hold the crt securely and tighten their grip as the crt encounters shock.

Improved cabinet feet and top stacking guides of vinyl rubber were developed to absorb shock and thereby limit the shock forces applied to the crt and other components and structures. Maximum shock applied to the crt with this system was 80 g's, well within the 100 g target.

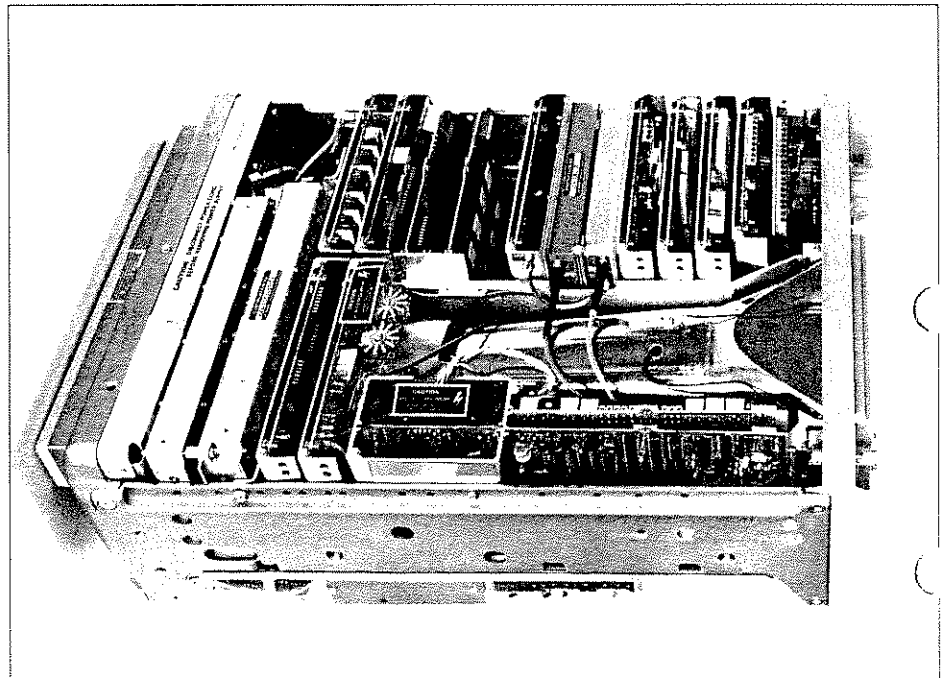

Figure 1. The 492 without covers.

492 Specifications

FREQUENCY RELATED

Frequency Range — 50 kHz to 21 GHz with internal mixer, to 220 GHz with external mixers. Option 08 deletes coverage above 21 GHz (calibrated mixers to 60 GHz available from Tektronix).

Frequency Accuracy — $\pm 0.2\%$ or 5 MHz, whichever is greater, $+20\%$ of span/div.

Frequency Readout Resolution — Within 1 MHz.

Frequency Span per Division — 10 kHz to 200 MHz plus zero and full band max span, down to 500 Hz with Option 03 in 1-2-5 sequence.

Frequency Span Accuracy — $\pm 5\%$ of span/div, measured over center eight divisions.

Resolution Bandwidth @ 6 dB Points — 1 MHz to 1 kHz (100 Hz for Option 03) in decade steps within $\pm 20\%$, manually or automatically selected.

Resolution Shape Factor (60/6 dB) — 7.5; maximum.

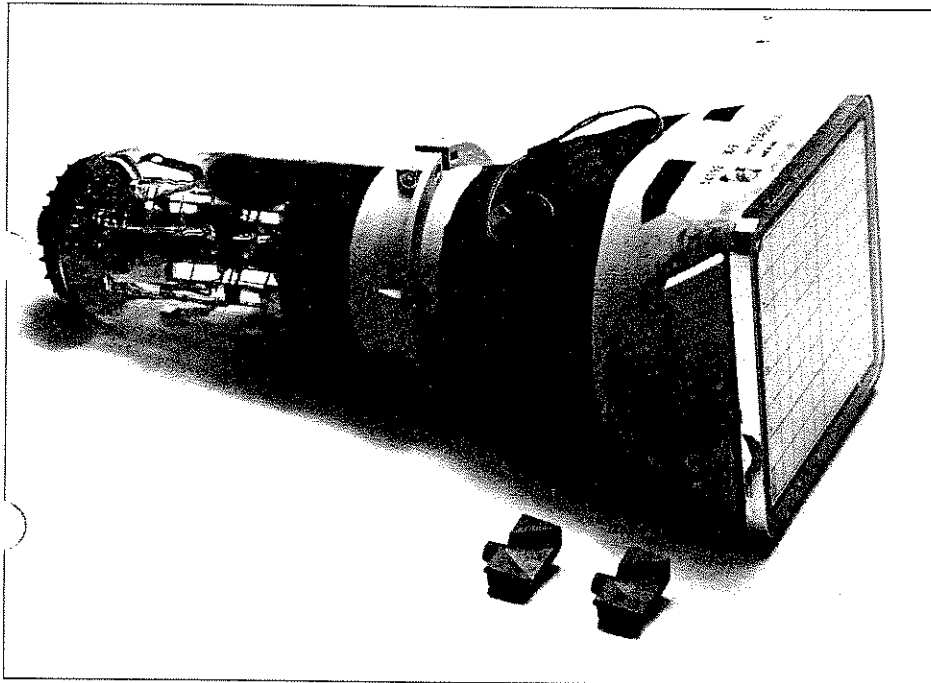

Figure 2. The ruggedized crt and crt mounting wedges.

Mechanical innovations enhance maintainability and performance

Many other innovations, while not major in themselves, enhance the buildability, maintainability, usability, and appearance of the 492 instrument.

Several options allow the user to order the 492 configured for a particular application. To simplify the production changes required by these options the traditional anodized-aluminum front panel has been replaced by a clear polycarbonate-plastic front panel laminated to an aluminum back plate. The panel nomenclature and colors are silk-screened on the back of the polycarbonate. Thus panel nomenclature resists deterioration and the front panel becomes highly scratch resistant.

The rf deck is also designed to facilitate the addition or deletion of components and contributes to the design goal of maintainability. Any rf component can be removed or installed in less than ten minutes.

A new method of making semi-rigid coaxial-cable connections, used in the 492, contributes to a very low voltage standing wave ratio (between 1.01 to 1.02:1.00). The outer conductor of the coax is flared to receive a ferrule and nut which screws on the female portion of the connector. This replaces the traditional soldered connection.

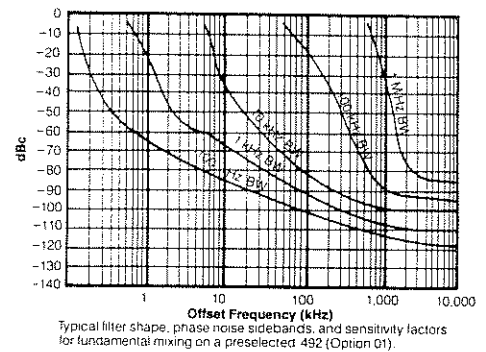

SPURIOUS RESPONSES

Residual (no input signal) — -100 dBm or less referenced to input mixer for fundamental conversion.

Harmonics — At least -60 dBc for full screen signal in the Min Distortion mode to 21 GHz. At least -100 dBc for preselected Option 01. 1.7 to 21 GHz.

Intermodulation — 3rd order products at least -70 dB down from two full screen signals within any frequency span in the Min Distortion mode. At least -100 dB down for two signals spaced more than 100 MHz apart from 1.7 to 21 GHz for preselected Option 01.

STABILITY

(after 2 hour warm-up)

Residual FM — $(1 \text{ kHz p-p}) \times n$ (mixing number) for 2 ms time duration, improves to $(50 \text{ Hz}) \times n$ for 20 ms with phaselock Option 03.

Long Term Drift: 200 kHz/hour unphaselocked, 25 kHz/hour phaselocked for fundamental mixing.

Noise Sidebands — At least 75 dBc @ 30X resolution offset (70 dBc for 100 Hz resolution) for fundamental mixing.

AMPLITUDE RELATED

Reference Level Range — -123 dBm to $+40$ dBm ($+30$ dBm maximum safe input) for 10 dB/div and 2 dB/div log modes. 20 nV/div to 2 V/div (1 W maximum safe input) in the linear mode.

Continue to page number 13

A First Converter with Field Replaceable Diodes

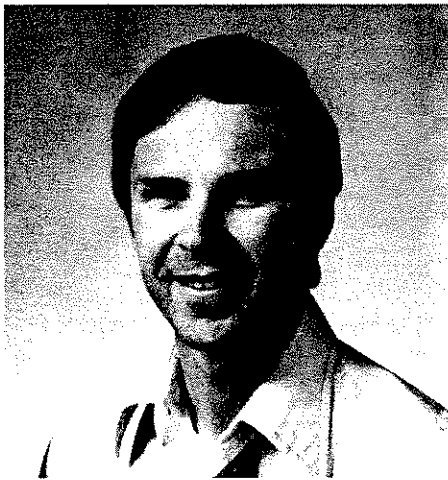

Phil Snow received his BSEE from California State University, L.A. in 1962. Prior to coming to Tektronix in 1974 he designed radar receivers and radar receiver components and was a microwave hybrid processing services consultant. Phil is presently manager of the Microwave Technology Group in Tektronix Labs. He is the author of papers on surface acoustic wave filters and fabrication. His inventions include the "Resistive Weighted Transducer," and a "Microwave Integrated Circuit Package." Phil and his family live in the Beaverton, Oregon area.

The instrument architecture of the 492 requires that the first converter, or input mixer, operate from 50 KHz to 21 GHz. This wide range of input frequencies precludes using a double-balanced mixer since it is not presently possible to build an appropriately coupled input-signal feed-structure that will function over such a broad frequency spectrum.

Since the first local oscillator (LO) of the 492 tunes over a frequency range from 2 to 6 GHz, a *single-balanced mixer*, in which the LO and RF/IF ports are isolated, is the best choice. Single-balanced mixers generate just one-half the intermodulation (IM) products of an unbalanced mixer and reduce the signal level of the LO at the RF port, an important factor for a 492 when operated without a preselector.

A stripline 3 dB quadrature coupler cascaded with a 90 degree phase shifter is chosen as "nearly optimum" for the first converter. This configuration provides broadband microwave performance in a converter package that is easy to build, reliable, and reasonably priced. The diagram in figure 1 shows the concept of this four-port network.

A port-to-port analysis of the cascaded distributed circuits in figure 1 reveals that a voltage applied to port 1 produces equal voltages (reduced by a factor of 0.707) at ports 3 and 4, with a 180 degree phase difference. Equal in-phase voltages applied at ports 3 and 4 will add at port 2 and cancel at port 1.

Experience from lower-frequency, lumped-element designs indicates that the junction of two Schottky diodes makes an ideal RF port, with the LO applied to port 1. Since the impedances of the coupler and phase shifter affect the input match at the RF port, the distributed network is designed to operate from 2 to 21 GHz instead of just the 2 to 6.3 GHz range of the first LO.

Port 2 is selected as the IF port because IM products generated in the diodes are summed in-phase at this port and do not have to be filtered out at the RF port. Since the RF and IF ports are not isolated, a directional filter selects the 2.072 GHz IF. A diplexer selects the 829 MHz IF (see figure 2). These filtering structures are used because they provide a broadband match to the non-isolated RF and IF ports.

Due to the reflected resistance of the balanced feed (50 ohms at ports 3 and 4), the usual mixer conversion loss is increased by about 3 dB, because half of the RF power is lost in the resistive loads that appear in series with the Schottky diodes. Another 3 dB is lost in the power split between RF and IF ports since converted power is removed from only *one* port.

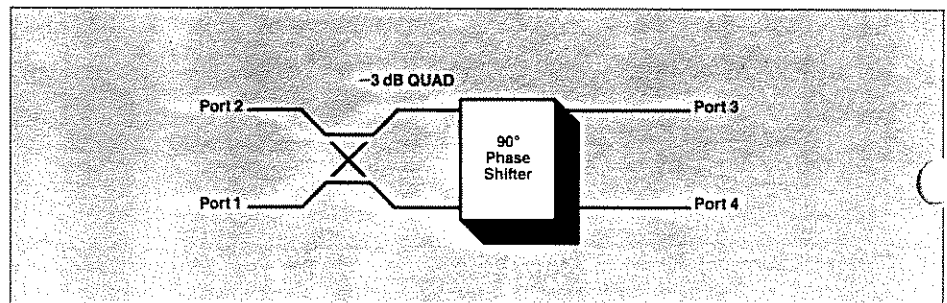

Figure 1. A stripline quadrature coupler cascaded with a 90-degree phase shifter provides broadband microwave performance in a converter package that is easy to build, reliable, and reasonably priced.

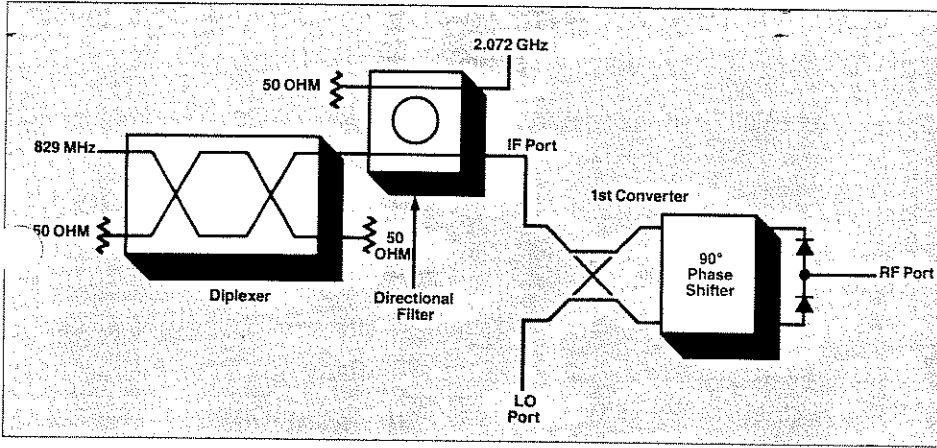

Figure 2. Simplified block diagram showing first converter inputs and output, and selection of the 829 MHz and 2.072 GHz IFs.

Thus, the first converter has an intrinsic loss of about 12 dB compared to the usual 6 dB. However, a very-flat (± 1 dB typical) fundamental is achieved.

Low capacity (0.1 pF) and low-inductance (0.1 nH) beam-lead Schottky diodes are used as switching devices in the first converter to achieve wide-band performance to 21 GHz. The Schottky diodes are mounted on a quartz thin-film suspended substrate. The substrate is mounted directly into the stripline feed-structure of the converter (see figure 3.)

The mixer housing need not be opened to replace the Schottky diodes; only a small, easily removable "dual diode assembly" is involved. This simplifies field replacement of diodes exposed to excessive input power.

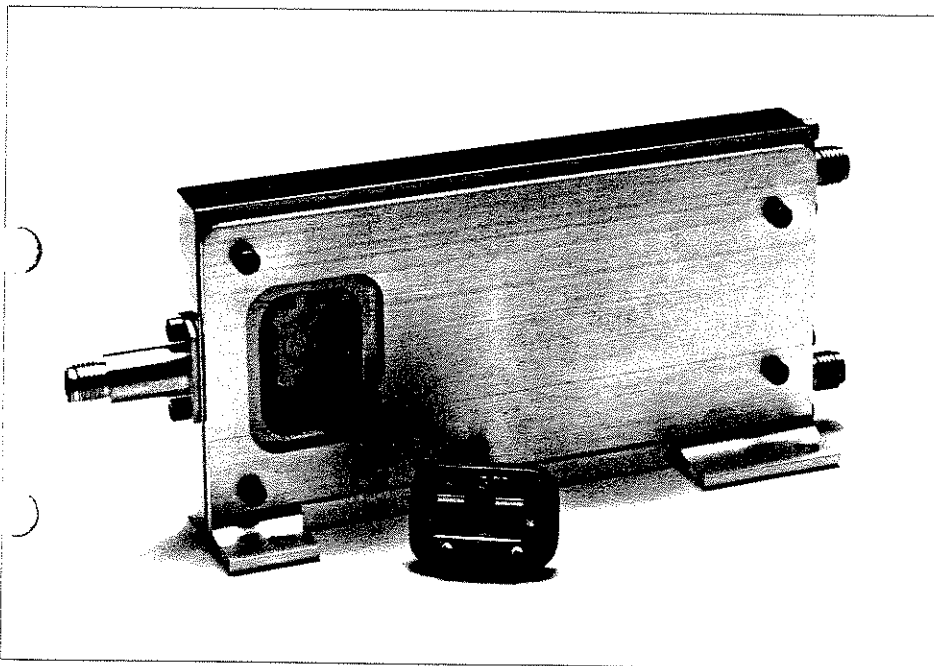

Figure 3. The first converter with the easily-replaceable input-diode assembly.

Additional 492 Specifications

Reference Level Steps — 10 dB, 1 dB, and 0.25 dB for relative level (Δ) measurements in log mode. 1-2-5 sequence and 1 dB equivalent increments in LIN mode.

Reference Level Accuracy — Amplitude change of 0.25 dB ± 0.05 , 1 dB ± 0.2 dB, 10 dB ± 0.5 dB; to a maximum of ± 1.4 dB for 60 dB and ± 2 dB for 90 dB reference level change when gain change and attenuation do not offset each other.

Display Dynamic Range — 80 dB @ 10 dB/div, 16 dB @ 2 dB/div and 8 divisions linear.

Display Amplitude Accuracy — ± 1 dB/10 dB to maximum of ± 2 dB/80 dB; ± 0.4 dB/2 dB to maximum of ± 1 dB/16 dB; $\pm 5\%$ of full screen in LIN mode.*

Resolution Bandwidth Gain Variation — ± 0.5 dB.

*Flatness and accuracy specifications do not apply to the 30, 40, 50, and 60 dB f attenuator positions between 19 and 20 GHz.

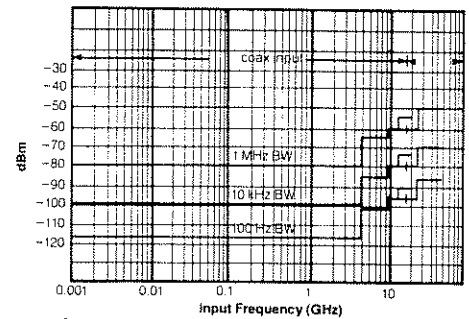

Sensitivity showing average noise level for a preselected 492 (Option 01).

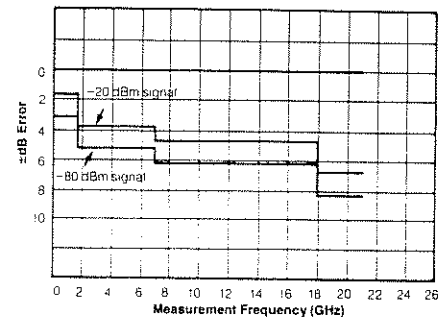

Cumulative maximum absolute amplitude measurement error as a function of amplitude and frequency for a preselected 492 (Option 01)

INPUT CHARACTERISTICS

Internal Mixer — Type N female connector, VSWR 1.45 to 18 GHz, and 3.5 to 21 GHz; with 10 dB or more attenuation.

Optimum Level for Linear Operation — -30 dBm referenced to mixer.

1 dB Compression Point — -28 dBm from 1.7 to 2 GHz for Option 01; otherwise -10 dBm.

Maximum Safe Input Level — +13 dBm without Option 01, +30 dBm (1 W) with Option 01, zero r_f attenuation.

Attenuator Power Limit — +30 dBm (1 W) continuous, 75 W peak for 1 μ s or less pulse width and 0.001 maximum duty factor.

PHYSICAL

Environmental Characteristics — Per MIL-T-28800B type III, class 3, style C.

Configuration — Portable, 20 kg (44 lb) (all options), 12 x 32.7 x 49.9 cm (6.9 x 12.9 x 19.7 in) without handle or cover.

A Switching Power Supply for the 492 Portable Spectrum Analyzer

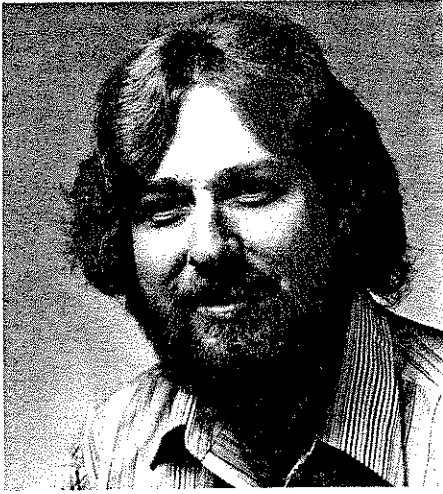

David Leatherwood joined Tektronix in 1976 bringing with him experience in miniaturized and militarized power supplies. He has been in power conversion since he received his B.S.E.E.T. from University of Houston in 1974. He is currently a project engineer with the Power Supply Design Group. A native of Texas, David and his wife and three children live in Portland, Oregon. A member of the Sierra Club, he collects wine and repairs TVs (for neighbors and acquaintances who discover his occupation.)

Until recently the weight and power consumption of conventional supplies have made the high-performance *portable analyzer* a rarity. Therefore, the power-supply design group for the 492 needed to develop a compact, high-efficiency supply. One that was compatible with the noise-sensitive circuitry of the proposed analyzer.

The 492 Spectrum Analyzer's high accuracy called for extensive use of power-consuming linear circuits. The portability objective placed stringent limits on weight and size. The instrument would also have to meet the requirements of MIL-T-28800 general specifications,

as well as the specifications for electromagnetic interference of MIL-STD-462. High performance and reliability were major design criteria. And UL and IEC safety requirements were additional design goals. Added to the challenge was the noise-sensitive nature of spectrum analyzer circuits.

A pulse-width modulated supply

A pulse-width modulated (PWM) circuit topology offered the way to greatly reduce weight and increase the efficiency of the 492 power supply.

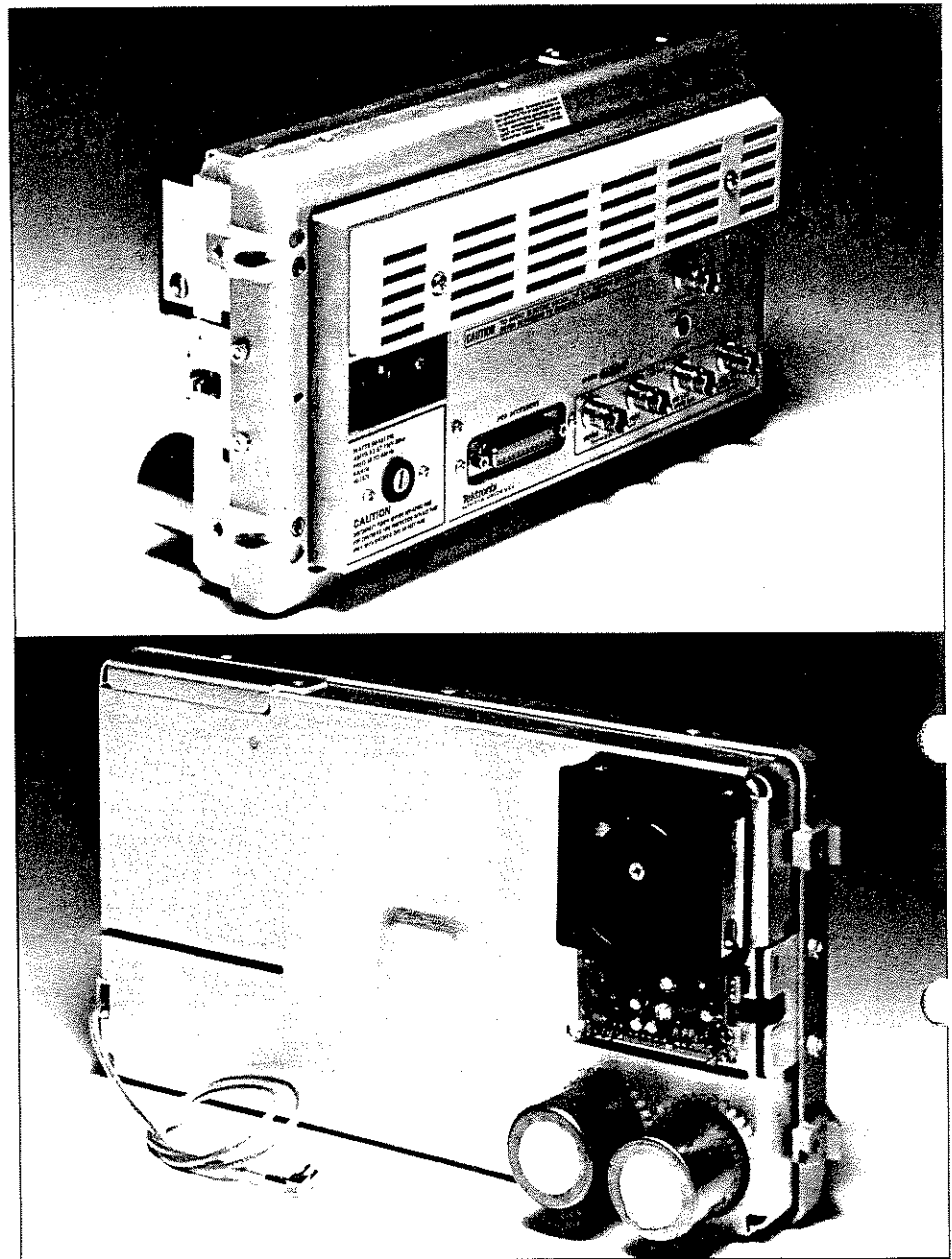

Figure 1. The plug-in power supply is easily replaced.

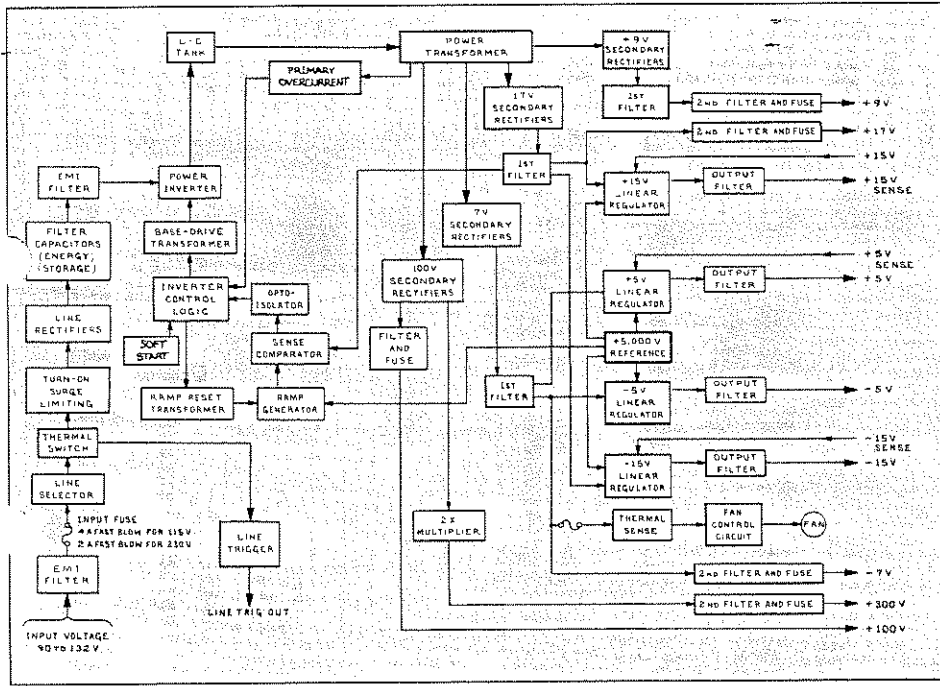

Figure 2. 492 Power supply block diagram.

The pulse-width modulator is a high-frequency, power-switching circuit. Output voltage is controlled by varying the duty cycle.

However, this approach required additional normal-mode and common-mode line filters that were low in radiating or receiving stray fields.

Design highlights

Fast recovery diodes with resistive/capacitive units (snubbers), which damp energy during diode turn-off, are used as the main line rectifiers. Bleeder resistors connected to the primary supply rectifiers eliminated the weight of a separate "housekeeping" supply for control logic.

The relatively-high switching frequency of 33 kHz used in the converter simplifies filtering and improves regulator transient response. The output-sense feedback to the primary control circuits is quick acting, using a digital signal coupled via a high-speed optoisolator (typical data-rate capability of 10 megabits per second.) Such speeds are necessary because propagation delay contributes to inadequate phase margin and poor loop stability.

The heart of the power supply is the main silicon switching transistors that convert dc voltage from the line-filter capacitors to ac square-wave power at the transformer primary. The transistors were selected for short storage time and isolated cases. Short storage time allows switching at the 33 kHz rate without damage and noise-generating cross conduction, while the isolated case prevents electrostatic coupling of collector-switching signals to chassis ground.

A PWM supply requires an averaging inductive filter on each of the nine outputs to dc average the switching waveform. Lumping nine secondary inductors in a single primary-tank choke reduced the space required for the required filtering in the 492 supply.

In a PWM power-supply tank circuit the peak-to-peak primary voltage can be regulated to any value up to the dc input voltage supplied to the switching transistors by simply varying the input pulse width. The switching waveform's fundamental component is passed through a series-resonant tank to the power transformer with little loss and the harmonic content is rejected by the reactance of the inductor.

When the duty cycle is reduced by increasing transistor hold-off time in response to load or line variations, the fundamental component decreases, causing a reduction in primary voltage. The filtering effect of the series L-C transforms an approximately 400 volt pulsating voltage into a symmetrical square-wave voltage and a sinewave current. With square-wave voltage and sinewave current in the secondary, output diodes switch at the zero crossing of current. This greatly reduces switching losses and electromagnetic interference (EMI) generation caused by diode "snap."

The many supply voltages required by the 492 are provided by three secondary windings on the 33 kHz power transformer. These pre-regulated voltages are used for on-site three-terminal regulators and for non-critical loads such as heaters, solenoids, and graticule illumination.

Circuits requiring tightly regulated voltages, (typically less than 0.5% over full line and load variations), are supplied by four linear series-pass regulators. These regulators, are fed by the pre-regulated voltages to greatly increase operating efficiency.

Most 492 circuits plug into a main mother board. Rather than have power distributed in a random manner to the various elements, a central power area was established on the mother board. The regulated outputs are remotely sensed in this area and radially distributed to the plug-in module circuits. In this way, circuit-run losses are compensated and circuit interaction is minimized.

The entire switching power supply can be easily replaced for field repair or operated on an extender for ease in servicing. ➤

New Products

Data Analyzer Combines State, Timing, Serial, and Signature Analysis.

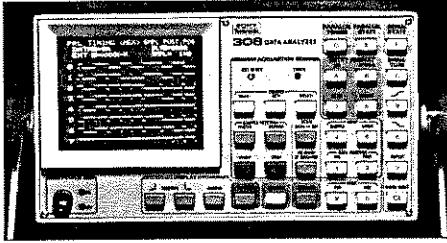

308 Data Analyzer

The 308 Data Analyzer is a keyboard controlled multi-functional, portable data analyzer. It can be operated as a parallel timing analyzer, a parallel state analyzer, a serial state analyzer, or a signature analyzer.

The parallel timing analyzer provides 8 channels at 20 MHz with 252 bits/channel memory size. The 8 channel parallel word recognizer provides internal triggering upon recognition of preset digital-system state; this capability is expandable to 24 channels with the optional P6406 Word Recognizer Probe. Digital delay counts up to 65,535 clocks; data can be stored at sample intervals of 50 ns to 200 ms.

Parallel state analyzer functions are similar to the parallel timing analyzer functions except that displays are in binary, octal, and hexadecimal format.

The serial state analyzer acquires 5, 6, 7, or 8 bits/character data synchronously or asynchronously. Two-character word recognition provides internal triggering upon recognition of present digital system state. Digital delay counts up to 65,535 words; data can be stored at baud rates of 50 baud to 9600 baud. The stored data is displayed on the crt screen in binary, hex, and ASCII format.

New State-Of-The-Art in Audio Signal Purity

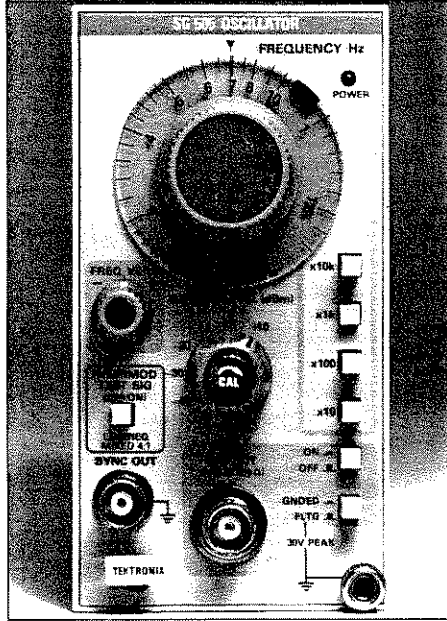

SG 505 Oscillator

The SG 505 establishes a new state-of-the-art in signal purity (0.0008% THD). This top-of-the-line sinewave oscillator, addresses the needs of professional audio measurement. The SG 505 is another in the growing line of TM 500 Modular Test and Measurement products.

FEATURES

Frequency Range: 10 Hz to 100 kHz

Harmonic Distortion: $\geq 0.0008\%$

THD (typically 0.0003%)

Calibrated Output: Yes

Step Attenuators Range: +10 to -60 dBm ± 0.1 db.

Level Flatness (audio range): ± 0.1 dB.

Maximum Output Voltage: 6 V rms.

Sync. Output: 200 mV rms sinewave.

Intermodulation Test Signal: Option 01.

High Level Language Support for Motorola 6800 And 6802

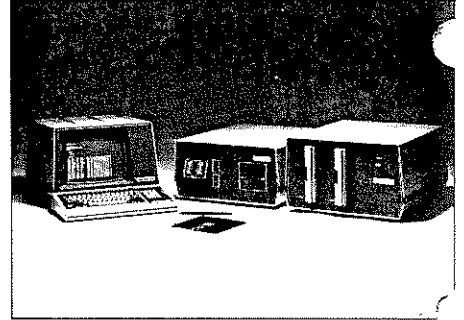

8002A Microprocessor Lab 6800 Modular Development Language

The 6800 Modular Development Language (MDL/6800) is an option for the 8002A Microprocessor Lab. This option broadens the high-level language support offered by Tektronix for the Motorola 6800 and 6802. The total MDL/ μ offering now includes the 8080A, 8085A, the 8080A subset of the Z80A, 6800, and 6802.

MDL/6800 is a modified form of ANSI minimal BASIC. It supports modular programming and the use of specific 6800/6802 features and 8002A I/O resources. This allows program development to be divided among several engineers working in parallel. Software can then be developed in modular components and compiled separately. Subroutines and data defined in one module may be referenced by another. The 6800/6802 I/O and interrupt structures as well as 8002A peripherals and file I/O can be accessed with MDL/6800 constructs. The language provides data handling capabilities for integers, strings, and arrays of these types.

Tektronix, Inc.

P.O. Box 500
Beaverton, Oregon 97077

1195114 2545
MR F CAPELLUPO ENGR
NEW YORK TELEPHONE CO.
8858 75 AVE
GLENDALE NY 11227

BULK RATE
U.S. POSTAGE PAID
TEKTRONIX, INC.